

COOLIUS

A30

A/C Service-Unit for refrigerant R134a

Operating Manual

 Original Operating Manual



Introduction

Dear Customer,

Thank you for purchasing this product.

To ensure this condition and ensure safe operation, you must observe these operating instructions!

Read the entire operating instructions before using the machine for the first time. Observe all operating instructions and safety instructions!

All company names and product names are trademarks of their respective owners. All rights reserved.

If you have any questions, please contact the respective service partner of your country *See chapter 9 Contact and support p. 41*

Europa

This machine meets the requirements of valid EU directives.

2014/68/EU (PED)

2006/42/EU

2014/30/EU

2014/35/EU



Australia & New Zealand

RCM compliance



The Declaration of Conformity can be obtained from: www.coolius-ac.com

Reprinting, even in extract, is allowed only after obtaining approval.

We reserve the right to make changes to the product at any time, if we consider them to be in the interest of quality improvement, without prior notice or notification. Figures may be examples, which may differ in appearance from the goods delivered. We also reserve the right to errors, and cannot be held responsible for typographical mistakes. Our general terms and conditions apply.

Contents

1 Important notes on the operating instructions	5
1.1 Important information about refrigerant.....	6
1.2 Symbols.....	6
1.3 Intended use	6
2 Important safety instructions	7
2.1 Glossary of terms	7
2.2 General safety rules	7
2.3 Guidelines for handling refrigerants	8
2.4 Safety devices	9
2.5 Not condensable gas discharge.....	9
2.6 Ventilation Safety System	9
2.7 The work environment.....	9
3 Use of the machine	10
3.1 Machine description	10
3.1.1 Control panel.....	10
3.1.2 The machine	11
3.2 Transport lock.....	12
3.3 Machine handling	12
3.4 On/Off and stopping	12
4 Preparation for the use and settings	13
4.1 Machine start-up.....	13
4.2 Using the printer	14
4.3 Program selection	15
4.4 Download Service data	16
4.5 Setting	18
4.5.1 Machine set-up.....	18
4.5.2 Time-Date	19
4.5.3 Company data.....	20
4.6 Maintenance messages	20
4.8 Error messages	21
4.7 Vessel charge.....	21
5 Programs	23
5.1 New oil bottle change	23
5.2 Full service	25
5.3 A/C database	27
5.4 Owner DataBase.....	28
5.4.1 Creation of a vehicle	28
5.4.2 Selection of a vehicle	28
5.4.3 How to modify or delete a saved vehicle.....	29
5.5 Open program	30
5.5.1 Process setting.....	30
5.6 A/C pressure test.....	32
5.7 A/C flushing (UNLOCK CODE required).....	33
6 Maintenance	34
6.1 Operation history	34
6.2 Next service.....	34
6.3 Counter reset (UNLOCK CODE required).....	35

6.4	Filter replacement.....	35
6.5	Vacuum pump oil replacement.....	36
6.6	Report.....	37
6.7	Scale reset	37
6.7.1	Refrigerant Weight scale.....	38
6.7.2	Waste oil weight scale.....	38
7	Technical features	39
8	Disposal	40
8.1	Storage for long periods.....	40
8.2	Disposal of used fluids	40
8.3	Disposal of packaging material	40
8.4	Scrapping the old unit	40
9	Contact and support	41
9.1	Service Portal	41

1 Important notes on the operating instructions

COOLIUS A30 (the machine) has been designed and built to ensure long lasting, high-level operating reliability with maximum safety for user.



This operating manual is part of the machine.
Read carefully before use.

- The user is responsible for the proper use of the machine in accordance with the instructions found in this operating manual.
- The manufacturer cannot be held responsible for damage to persons, animals and/or objects due to improper use different to that illustrated in this instruction manual.
- The manufacturer reserves the right to make technical and aesthetic alterations to the machine without prior notification.

The purpose of this operating manual is:

- To supply the user with all the information needed to use the unit starting from purchase on through to the disposal of this same machine.
- To ensure maximum support for the personnel assigned to the use and the maintenance of the machine.

For any special information or requests for technical assistance or spare parts, please contact the Service partner of your country.

Disclaimer



This manual was created with great care. However, if you notice any omissions or inaccuracies, please inform the service partner of your country in writing.

The manufacturer shall not be liable for technical or typographical errors and reserves the right at any time without prior notice to the product and the instruction manuals make.

The illustrations in this document may differ from the machine actually supplied with this manual.

1.1 Important information about refrigerant



NOTE: All the information here is current as of the date of printing of this manual.



WARNING! The machine is designed exclusively for R134a. The design meets all the guidelines of the European standard EN 378:2016

Safety Classification and information about refrigerant:

The refrigerant is classified in Table E.1 (Refrigerants designation) of Annex E (Normative) of the European standard EN 378-1:2016 (E) EN 378-1:2016 (E)

ETHANE series: 134a (1,1,1,2-tetrafluoroethane)

Safety group: A1

PED fluid group: 2

The refrigerant can assume different names depending on the manufacturer!



For more information relating to the refrigerant refer to the SAFETY DATA SHEET according to Regulation (EC) No. 1907/2006 (MSDS).

The SAFETY DATA SHEET (MSDS) must be delivered to the operator (s) employee (s) using the machine!

1.2 Symbols



This safety alert symbol indicate that this message involves personal safety. Works danger, warning and caution indicate degree of hazard. Death, personal injury and/or property damage may occur unless instructions are followed carefully.



Do not operate this machine if you have not read and understood the following safety items. Read this entire Operating Manual.

1.3 Intended use

The machine is designed solely for use in automobile air-conditioning system maintenance.



CAUTION! Risk of injury due to improper use.

This machine is intended for use by Qualified personnel only. Such users must have a knowledge of the basics of refrigeration, refrigeration system, refrigerants and the potential hazards that unit under high pressure can cause.

2 Important safety instructions

The user should follow the “general safety rules”, and use the machine according to the “intended use” and the instructions of this operating manual.

Therefore, the user is not exposed to any risk if the general safety rules reported below are followed with proper use and maintenance of the machine.

2.1 Glossary of terms

- **Machine:** The machine relative to this operating manual.
- **Refrigerant:** Fluid reported on the identification label.
- **A/C system:** Air-conditioning system in the vehicle.
- **External bottle:** New Refrigerant used to fill the internal vessel.
- **Internal vessel:** Refrigerant storage tank.
- **Process:** Execution of an individual function (ex. Recovery).
- **Cycle:** Execution of more processes.
- **Recovery:** The recovery of refrigerant in any condition and its storage in a container outside the A/C system, without necessarily undergoing analysis or treatment of any kind.
- **Recycling:** A reduction of the contaminating substances in used refrigerants through oil separation, the recovery of incondensable and their single or multiple passages through elements that enable a reduction in humidity, acidity and gasses.
- **Disposal:** Recovery of refrigerant to store it for subsequent distribution or disposal.
- **Vacuum:** Phase in which air and moisture are evacuated from an A/C system solely by means of a vacuum pump.
- **Oil charge:** Introduction of oil inside an A/C system for the purpose of maintaining the amount of oil specified by the manufacturer.
- **UV dry charge:** Introduction of UV dye inside an A/C system in order to detect possible leaks by means of a UV lamp.
- **Refrigerant charge:** Phase during which refrigerant is introduced into an A/C system in the amount specified by the manufacturer.
- **Flushing:** at the purpose to clean the A/C system or components, liquid refrigerant is flushed through it, in order to do so a special device and adapters are needed.

2.2 General safety rules

- This machine is intended for use by QUALIFIED PERSONNEL only. Such users must have a knowledge of the basics of refrigeration, refrigeration system, refrigerants and the potential hazards that unit under high pressure can cause.
- It's essential to supervise the machine at all times.
- DO NOT modify the safety devices
- DO NOT use external tanks or other storage tanks that have not been type-approved or that lack safety valves.
- DO NOT use the machine near open flames and hot surfaces. At high temperatures, the refrigerant decomposes, releasing toxic and chemical substances that are hazardous for users and the environment.
- It's essential to use only the refrigerant indicated on the identification label. Mixtures with other types of refrigerant will seriously damage the cooling and refrigeration system, as well as the machine.

- Gloves and goggles should be worn - contact with the refrigerant can cause blindness and other physical injury to the user.
- Avoid inhalation of vapours from the refrigerants and contact of the refrigerant with skin.
- Do not switch on the machine unless the machine is going to be used immediately. Cut off the electrical power supply prior to long intervals in which the machine will not be used.
- **Attention:** Ensure that all valves are closed before making connections between the machine and an A/C system or an external tank.
- **Attention:** Ensure that the process has been completed and that all valves are closed before disconnecting the machine.
- **Attention:** All of the flexible hoses may contain refrigerant under high pressure. Exercise extreme caution when disconnecting the service hoses.
- **Attention:** The machine and A/C system in vehicles containing refrigerant should not be tested with compressed air. Some mixtures of air and refrigerant have proven to be combustible at high pressure levels. These mixtures are potentially hazardous and there is a risk of fire and explosions that can cause damage to property and personal injury. Additional medical and safety information can be obtained from the manufacturers of the oils and refrigerants.

2.3 Guidelines for handling refrigerants

Precautions for Refrigerant Storage

The refrigerant to be removed from a system must be handled carefully in order to prevent or minimise the possibilities of different refrigerants mixing.

The tank used for storing refrigerants must be assigned to specific refrigerants to avoid different refrigerants mixing

Recycling Capacity

The recycling machine's filter system should be replaced regularly in order to maintain the efficiency of the recycling machine

General Notions

Before re-introducing refrigerant into the system, the system itself must be evacuated and cleaned.

In order to be sure that the system is free of contaminating agents before introducing the refrigerant, all the procedures described in this instruction manual must be followed.

Clean and maintain the machine regularly, especially when highly contaminated refrigerant is used: it is extremely important that contamination from the previous operation is not transferred to subsequent operations.

2.4 Safety devices

The machine is equipped with the safety devices required from the European Directives:

- Electric safety switch
- Safety valve



CAUTION! *Danger of injury due to manipulation.*
DO NOT MODIFY THE SAFETY DEVICES.

2.5 Not condensable gas discharge

A not condensable gas discharge valve is installed to allow these gasses to be released.

The not condensable gas discharge valve could generate noises.



WARNING! *Risk of injury from escaping gases under high pressure.*
Make sure that you never come in contact with the drain valve!

2.6 Ventilation Safety System

The machine is equipped with a ventilation security system which allows the use in high temperature environments.

It is forbidden to obstruct the inlet grid of the fan.

2.7 The work environment

- The machine must be used in well ventilated environments (at least 4 changes of air per hour).
Protect the machine against atmospheric agents (such as avoiding direct exposure to sunrays, rain, etc...).
- The unit has been designed for use at a maximum altitude of 1000 m above sea level, within a temperature range of +10 and +49°C and with a maximum humidity of 50% at +40°C.
- Operate in sufficiently lit conditions.

3 Use of the machine

3.1 Machine description

3.1.1 Control panel

1. Display
2. START button / LED
3. STOP button / LED
4. Information button (i)
5. Cancel button (X)
6. COOLIUS SELECT with ENTER button / LED
7. Right button / LED
8. Left button / LED
9. Printer
10. USB-Port

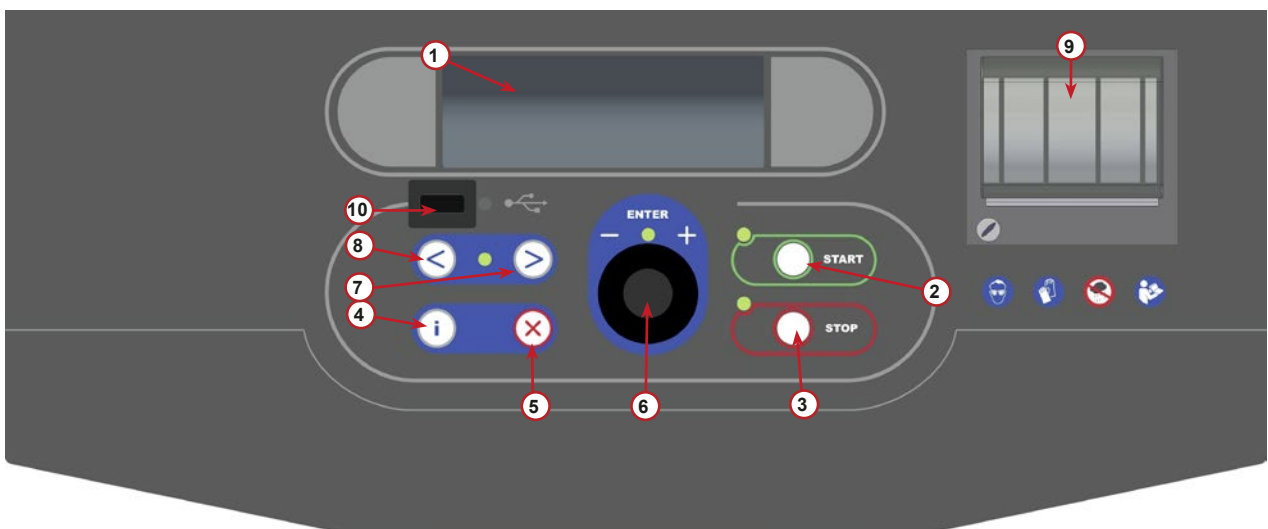

fig. 001 Control panel

3.1.2 The machine

- 1 LP pressure gauge
- 2 HP pressure gauge
- 3 Printer
- 4 Internal vessel pressure gauge
- 5 Front cover
- 6 Rear wheel
- 7 Front wheel with brake
- 8 Vacuum pump air grid
- 9 Main switch
- 10 Storage box for accessories
- 11 Drier filter
- 12 Container for waste oil 1000 ml
- 13 Container for UV leak detector 250 ml
- 14 Container for new oil 500 ml
- 15 LP quick coupling
- 16 HP quick coupling
- 17 LP hose
- 18 HP hose
- 19 By-pass

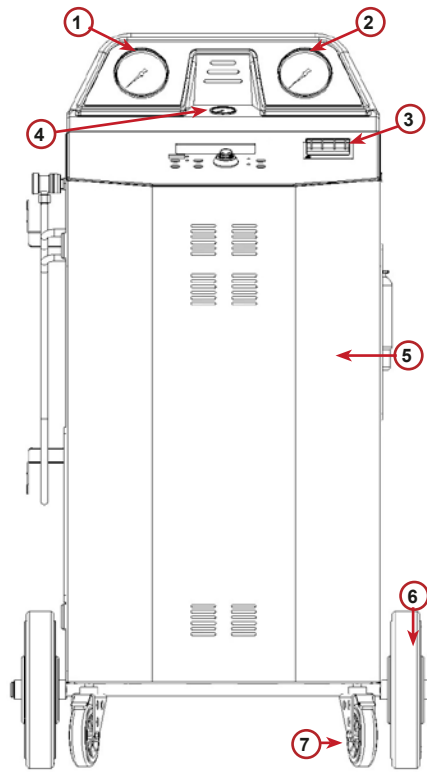

fig. 002 Front view

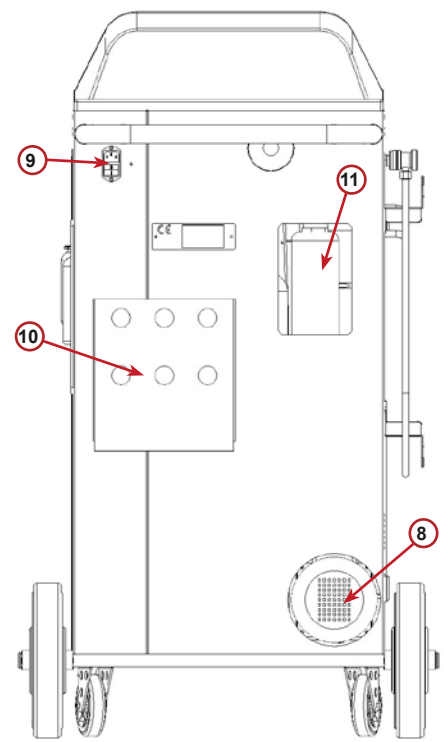

fig. 003 Rear view

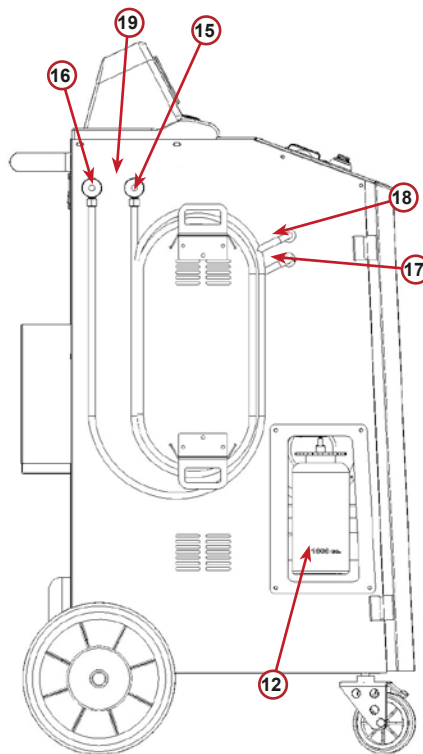

fig. 004 Left view

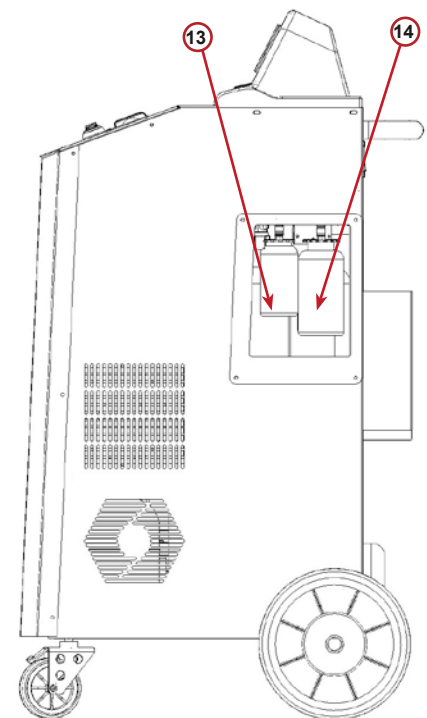

fig. 005 Right view

3.2 Transport lock

The transport lock secures the refrigerant weight scale and protects it from damage during transport.



ATTENTION! Possible damage to the refrigerant weight scale during transport.
The transport lock must be locked before transporting the A/C service unit.



ATTENTION! Risk of injury from electric shock.
Before working on the machine, always disconnect the plug from the power supply.

Switch OFF the machine and disconnect the plug from the power supply.
Remove the four large head Phillips screws that keep the plastic top cover with pressure gauges in place.
Then remove the plastic top cover and place it aside in order to have complete access to the inside of the machine.

Locking (TRANSPORT POSITION)

Install the two long screws of the transport lock.
Use an hex key to tighten the two screws and lift the refrigerant vessel holder.
The scale is now in transport position (the weight of the refrigerant vessel is not acting on the scale).

Unlocking (WORKING POSITION)

Use a **5 mm** hexagonal key to unscrew and remove the two long screws of the transport lock completely.
The scale is now in working position (the weight of the refrigerant vessel is acting on the scale).

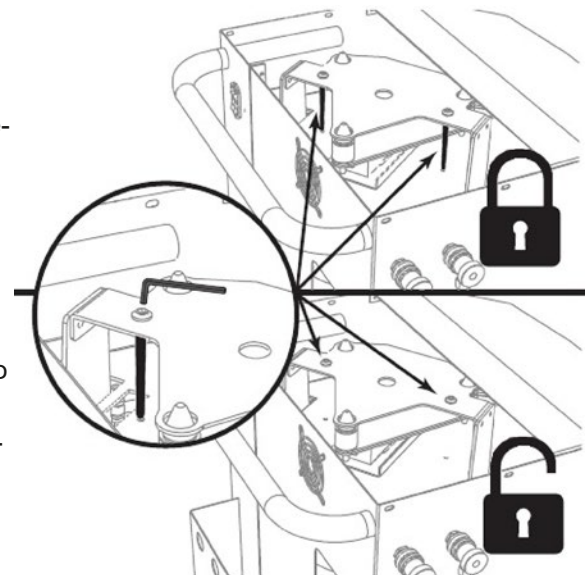

fig. 015 Transport position (top) and working position (bottom)

3.3 Machine handling

In spite of the fact that the heaviest components have been assembled on the base in order to lower the centre of gravity, it has not been possible to eliminate the risk of overturning completely.

The machine is moved on the four wheels.

On rough ground, the machine must be moved by tilting it and balancing the weight on the two rear wheels.

3.4 On/Off and stopping

Start-up: Move the main switch to the ON position (I)

Stopping: Move the main switch to the OFF position (0)



ATTENTION! Damage to the machine.
Do not switch off the machine by unplugging the mains plug!

4 Preparation for the use and settings

4.1 Machine start-up

Press the Power Switch (I) to turn on the Machine.
The ventilation security system starts.

Switch on the machine for the first time and activation

Select the display language

Turn **COOLIUS SELECT** to select the language, then confirm by **ENTER**.

After selecting the language, you have two possibilities to work with the machine.

```
Select :
```

```
Language 03
```

```
□□■□□□□□□□□□□□□□□
```

1. Demo Mode

You can now activate the machine or work in demo mode.

NOTE: All functions will be full working except for the TIME-DATE menu, that is not available.

1. Press **STOP** to use the machine in DEMO MODE. (The machine starts-up and skip the activation procedure).
 - The display shows the number of days before the activation will be necessary to use the machine.
2. Press **START** to go to Stand-by mode.

```
"START" to activate  
the machine.
```

```
www.coolius-ac.com
```

```
Machine is working  
now in DEMO MODE!  
Day(s) left
```

```
10
```

2. Machine activation

1. Press **START** to activate the machine.

NOTE: After 10 days, starting from the first switch on, the display will show only this screen at the start-up.

2. To perform the activation, go to website www.coolius-ac.com or call your service partner and request the UNLOCK CODE related to the Serial Number written on the display (in this case, the Serial Number is AA000000).
3. Press **START** to continue with activation or press **STOP** to skip the activation procedure and start-up the machine in DEMO MODE.

```
Get UNLOCK CODE  
register:
```

```
AA000000
```

```
www.coolius-ac.com
```

NOTE: **STOP** key is available only if there is at least one day left for DEMO MODE, otherwise the activation is compulsory and only the **START** key is available.

To continue with the activation it is required the knowledge of the UNLOCK CODE.

4. Enter the UNLOCK CODE using **COOLIUS SELECT**.
Once done, confirm by **START**.

- If the UNLOCK CODE is wrong, repeat the step 4 of the procedure.

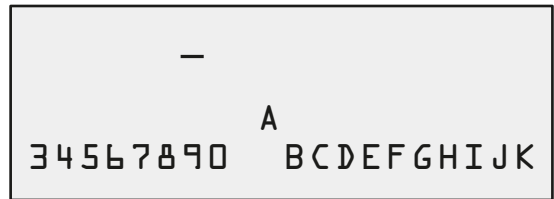

- If the UNLOCK CODE is correct, press **START** to confirm. The machine is activated and goes to Stand-by mode.

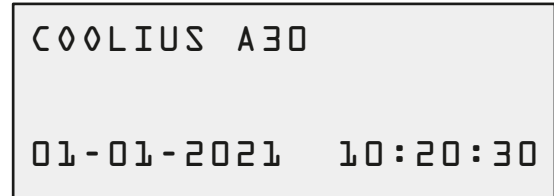

4.2 Using the printer

The machine has a built-in roll-up printer which can be used to print the vehicle data and the results of the maintenance work.

- Paper width: 58 mm
- Diameter: 40 mm
- Paper feed ①

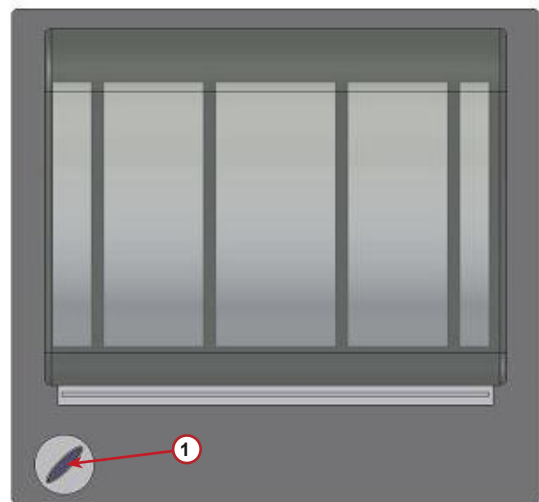

fig. 016 Roll-up printer

Before a process:

Turn **COOLIUS SELECT** to select the character then confirm by **ENTER**.

Max 20 characters (plate, chassis, etc...).

At the end of a process:

Press **START** key to print.

Press **STOP** key to end.

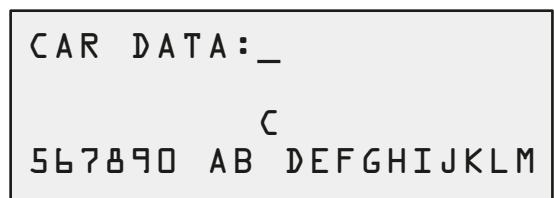

4.3 Program selection

Press *i* (INFO) key to check the refrigerant available.

Press *i* (INFO) key to go back to stand-by mode.

Press **ENTER** to select a menu item.

.

Turn **COOLIUS SELECT** to select the required program.

The symbol shows the current position of the cursor.

The number of symbols shows the number of available menu points of this level.

```
Available quantity:
Refrigerant g. // // // //
```

```
01-01-2021 10:20:30
```

```
Full Service
```

```
    
```

Overview of the menu contents

1. OTHER SELECTIONS

- SERVICE
- A/C PRESSURE TEST
- A/C FLUSHING
- NEW OIL BOTTLE CHANGE
- MACHINE SET-UP
- TIME-DATE
- COMPANY DATA
- SCALE RESET
- MAINTENANCE

2. A/C DATABASE

3. FULL SERVICE

4. OPEN PROGRAM

5. VESSEL CHARGE

4.4 Download Service data

Starting from the first switch on of the new year, the display shows:

```
Download
SERVICE DATA!
```

Press **STOP** to by-pass or **START** to download.

NOTE: When the service data of two different years are stored in the machine and current year is different from the two years saved, it is necessary to delete the data of at least one of the two years in order to continue with the start-up of the machine.

If **START** is pressed, then the display shows:

Type the password: **200200**

NOTE: This password can be also used in
OTHER SELECTIONS > SERVICE

```
—
A
3 4 5 6 7 8 9 0  B C D E F G H I J K
```

Then the display shows:

Turn **COOLIUS SELECT** to select the year to be downloaded then press **START** to confirm, the display shows:

```
Year                2020
```

Insert an empty USB stick.

NOTE: The file-system of the USB stick must be FAT32, if not please format it.

```
Insert a USB stick!
```

The download starts when the stick is detected and the display shows:

The last line of the screen indicates the progress of the downloading process.

```
Downloading!

Please wait!
Record                11/46
```

NOTE: Please do not remove the USB stick during the process to avoid damages to the stick and to the machine.

When the download is completed, the display shows:

```
Download
Completed!
Remove USB stick
```

Remove the USB stick, then the display shows:

```
Year                2020
Delete data?
Confirm by "START"
```

Press **START** to delete the data or press **STOP** to exit and keep the data stored in the machine.

IMPORTANT NOTE: Before deleting data, make sure that the downloaded file is kept in a safe place. The erasing process is not reversible!!

If **START** is pressed, the display shows:

```
Delete data?
Confirm again!
```

Press **START** key to confirm or **STOP** to go back to previous screen.

If **START** is pressed, the display shows:

```
Please wait!
```

Wait a few seconds. The recorded data for the selected year is now deleted.

4.5 Setting

4.5.1 Machine set-up

The procedure allows to set the machine.

Turn **COOLIUS SELECT** to select MACHINE SET-UP. Press **ENTER** to confirm.

Recovery data on service ticket:

- The recovery data are reported on the ticket (recovered amount of refrigerant and oil).
- The recovery data are not printed.

Turn **COOLIUS SELECT** to select or .
Press **ENTER** to confirm.

```
Print recovery
data?
      1
```

Refrigerant residual check:

The value is used as default parameter in:
A/C DATABASE and FULL SERVICE

Turn **COOLIUS SELECT** to set. Press **ENTER** to confirm.
The next menu item is displayed.

```
Residual refrigerant
check
                        min. 2
```

Leak test:

The value is used as default parameter in:
A/C DATABASE and FULL SERVICE

Turn **COOLIUS SELECT** to set. Press **ENTER** to confirm.
The next menu item is displayed.

```
Leak test      min. 2
```

Fresh oil:

The value is used as default parameter in:
A/C DATABASE and FULL SERVICE

Turn **COOLIUS SELECT** to set. Press **ENTER** to confirm.
The next menu item is displayed.

```
PAG Oil      ml. 10
```

UV Dye:

The value is used as default parameter in:
A/C DATABASE and FULL SERVICE

Turn **COOLIUS SELECT** to set the value. Press **ENTER**
key to confirm.

NOTE: Set to bypass the process
The next menu item is displayed.

```
UV Dye      ml. 6
```

Hoses length:

Turn **COOLIUS SELECT** to set the service hoses length, then confirm by **ENTER**.
The next menu item is displayed.

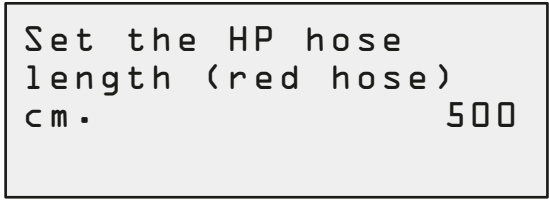

Language:

Turn **COOLIUS SELECT** to select the language, then confirm by **ENTER**.
The next menu item is displayed.

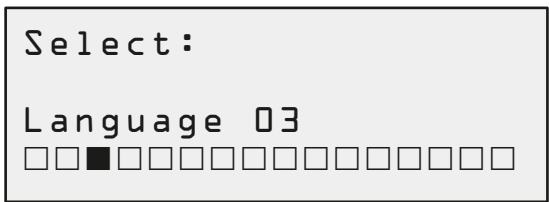

Unlock Code:

These eight digits are necessary to obtain the UNLOCK CODE for the counter reset. Request the new UNLOCK CODE on the website www.coolius-ac.com or call your service partner.
Press **ENTER**, then the next menu item is displayed.

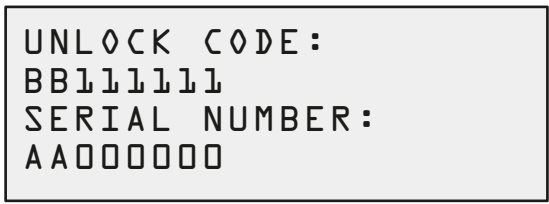

Printer:

- Printer built in.
- Printer off line or not installed.

Turn **COOLIUS SELECT** to select 1 or 0.
Press **ENTER** to confirm, then press **STOP** key to exit.

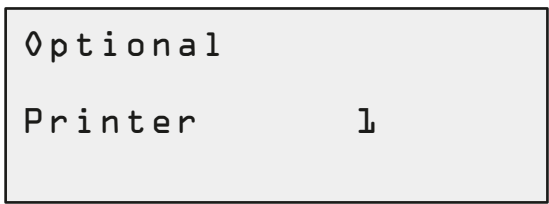

4.5.2 Time-Date

Turn **COOLIUS SELECT** to select TIME - DATE.
Press **ENTER** to confirm.

Turn **COOLIUS SELECT** to modify the blinking value.
Press **ENTER** to confirm. The next value blinks.

Press **START** key to confirm when the setup is completed.

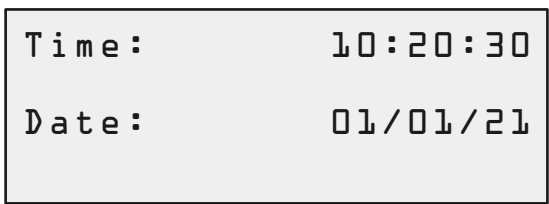

4.5.3 Company data

Turn **COOLIUS SELECT** to select COMPANY DATA.
Press **ENTER** to confirm.

5 lines are available:

- 1 _____ Company name (Workshop)
- 2 _____ Address (road, etc..)
- 3 _____ City
- 4 _____ Phone
- 5 _____ FAX

The above setting is an example only.

NOTE: These lines are reported on the service ticket.

Procedure:

- Turn **COOLIUS SELECT** to select the character.
Press **ENTER** to confirm, then the character is written on the blinking cell of first line.
- If required, press **X** key to delete.
- It is possible to move in the line by **LEFT / RIGHT**
- Turn **COOLIUS SELECT** to select the next character.
Press **ENTER** to confirm, then the character is written on the blinking cell of first line.
- Press **START** key to confirm the setting.
The display shows the following line.
- Press **STOP** when the setup of the 5 lines is completed.

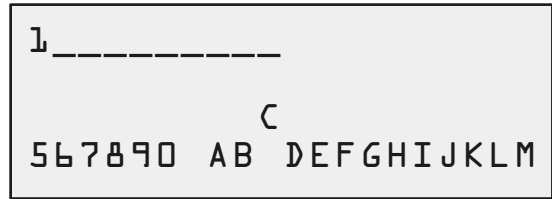

4.6 Maintenance messages



NOTE: Maintenance of the vacuum pump must be performed every 3000 minutes or at the latest after one year of operation, whichever is sooner.

The following messages can be shown at the start-up of the machine:

Notice: "MAINTENANCE WILL EXPIRE SOON!" or
"MAINTENANCE EXPIRED!"

Maintenance will expire soon!

Press **STOP** to continue with the start-up of the machine.

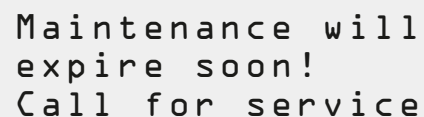

Maintenance expired!

1. Press **STOP** key when MAINTENANCE EXPIRED! message is shown.



2. Then the display shows:

Press **STOP** key and hold it for 5 seconds to continue with the start-up of the machine.

```
Get UNLOCK CODE
register:
BB111111
www.coolius-ac.com
```

NOTE: See chapter 6.3 Counter reset (UNLOCK CODE required) p. 35 to reset the maintenance counter.

4.8 Error messages

No	Error message	Description
A1	ERROR	A1 Scale blocked or faulty.
A3	ERROR	A3 Scale is loaded and is not possible to set the zero point. Unload the weight scale.
C1	ERROR	C1 Recovery process anomaly or compressor faulty
C5	ERROR	C5 Low pressure quick coupler (LP) is not connected to the A/C System during the flushing process.
F1	ERROR	F1 The pressure is too low to complete the A/C System Charge (in case of A/C System Charge performed by "HP PORT" only and LP quick coupler is not connected).
	ERROR! Overpressure in recovery process!	High pressure switch activated. Press STOP then wait 20-30 min. If the message appears again, please contact SERVICE CENTER.
	Vessel full! Please wait!	Maximum refrigerant quantity reached! Reduce the refrigerant quantity in the internal vessel.
	Leakage! "START" to by-pass	If after a few minutes the minimum vacuum value is not reached. Possible causes: defective A/C system, etc...
	Insufficient vacuum for oil/UV charge! "START" to by-pass	The vacuum value is not enough to guarantee the process. Possible causes: defective A/C system, air in the bottles, etc... Press START to by-pass the process and go to charge process.
	Insufficient refrigerant! Charge the vessel.	The refrigerant quantity is below the minimum quantity required. Perform "Internal vessel charge".

4.7 Vessel charge

The equipment may not contain enough refrigerant to run. The available quantity could be negative (Es: -500 g.) It will be necessary to add new refrigerant into the internal vessel before the use (at least 3 or 4 Kg).

1. Turn **COOLIUS SELECT** to select VESSEL CHARGE. Press **ENTER** to confirm.



NOTE: The message is shown before processes.

```
WARNING!
Verify Oil/UV
quantity in the
bottles.
```

2. Connect the LP (BLUE) or the HP (RED) hose to a new tank of refrigerant. If available, open the liquid tank valve (RED).
Otherwise turn the tank up-side-down.

```
Connect LP or HP
hose to ext. tank.
Open the valve
liquid side.
```

3. Turn **COOLIUS SELECT** to set the value.
 - Minimum: 800 g.
 - Maximum: the value shown by the display.

```
Set the quantity.
```

```
g.////////
```

4. Press **ENTER** to confirm.

5.

6. Press **START** key to confirm

```
Confirm by "START"
```



MESSAGE: *If the equipment senses a pressure lower than the minimum value for the process.*

```
Check:
Ext. tank empty or
tank valve closed.
```

The process starts.

```
Vessel charge in
process.
Pressure      mb.
Refrigerant  g.////////
```



MESSAGE: *If the equipment senses a pressure lower than the minimum value for the process.*

- Replace the external tank, then press **START** key to confirm.
- Press **STOP** key to complete the process.

```
Check:
Ext. tank empty or
tank valve closed.
```

The process is completed.

7. Close the tank valve and disconnect the red hose from the tank.

Press **START** key to confirm.

```
Vessel charge end.
```

```
Close the external
tank valve.
```

```
Refrigerant recovery
from the
service hoses
```

8. Press **STOP** key to end.

Vessel charge end.

g.//////

5 Programs

5.1 New oil bottle change



NOTE: A/C System can be damaged.

If it is required to change the kind of compressor oil, the A/C machine will require flushing to prevent cross contamination of oils. This procedure cleans the hoses and pipes prior to new oil injection.

1. Turn **COOLIUS SELECT** to select OTHER SELECTIONS.

Press **ENTER** to confirm.

2. Turn **COOLIUS SELECT** to select
NEW OIL BOTTLE CHANGE.

Press **ENTER** to confirm

New oil bottl.change

3. Replace the oil bottle with the new oil bottle.

Replace oil bottle
with the new oil
bottle for specific
application.

250 ml oil bottle green pipe ①.

4. Press **ENTER** to confirm.

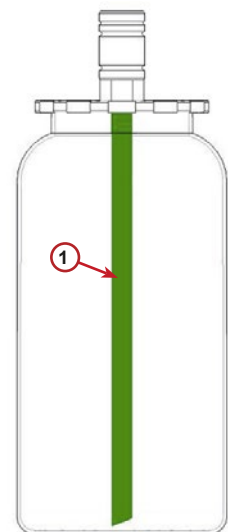

fig. 017 POE oil bottle

5. Perform the instruction.

Press **START** key to confirm.

Join HP/LP couplers
to the stand and
open the valves!
Confirm by "START"

6. The machine starts.

Internal flushing

Wait!

If the couplers are not joint to the stand or the coupler valves are not opened, message:

Press **START** key to confirm.

The machine starts. The process cleans the complete unit included the service hoses.

Join HP/LP couplers
to the stand and
open the valves!
Confirm by "START"

At the end:

Press **STOP** key to exit..

The machine is ready.

Internal flushing
end.

5.2 Full service

1. Press **ENTER** to go to selection menu (if in Stand-by mode).
2. Turn **COOLIUS SELECT** to select FULL SERVICE
3. Press **ENTER** to confirm.

Full service

□ □ ■ □ □

4. Turn **COOLIUS SELECT** to set the amount of refrigerant to be charged into the A/C system.

- Minimum: 50 g.

5. Press **ENTER** to confirm.

Refrigerant g. 500

6. Turn **COOLIUS SELECT** to set AUTOMATIC / MANUAL / NO
Press **ENTER** to confirm.

Oil/UV charge

Automatic

If AUTOMATIC is selected, then the display shows:

7. Turn **COOLIUS SELECT** to set oil quantity, confirm by **ENTER**, then set UV quantity and press **ENTER** to confirm.

PAG Oil ml. —
UV dye ml. —

8. Turn **COOLIUS SELECT** to set (usually HP)
HP PORT / LP PORT / HP/LP PORTS

Press **ENTER** to confirm.

Equipment with printer: [See chapter 4.2 Using the printer p. 14](#)

Charge A/C system by

HP PORT

9. Press **START** key to confirm.
The equipment performs all the processes.

- Recovery
- Residual refrigerant check
- Used oil drain process
- Vacuum, Leak test
- New oil charge
- UV Dye charge
- Refrigerant charge

Confirm by "START"

10. At the end of the processes, start the engine and A/C system, then check the pressures.

Verify the A/C system pressures.

1. At the end of the verification, press **STOP** key to end.
Perform the instruction.

```
Disconnect the HP/LP
service hoses from
the A/C system.
```

2. Press **START** key to confirm.

```
Refrigerant recovery
from the
service hoses
```

At the end, all the process values are reported on the display.

```
Recovery
Refrigerant   g.  ////
PAG Oil       ml.  //
```

```
Vacuum
                                     mb.  ///
```

3. Press **STOP** key to end.
Equipment with printer: [See chapter 4.2 Using the printer p. 14](#)
4. Press **START** key to print or **STOP** key to skip.

```
A/C system charge
Quantity       g.  ////
```

5.3 A/C database

The memory contains the data of the main cars on the market.

1. Press **ENTER** to go to selection menu (if in Stand-by mode).
2. Turn **COOLIUS SELECT** to select A/C DATABASE
Press **ENTER** to confirm.

A/C DataBase

□ ■ □ □ □

3. Turn **COOLIUS SELECT** to select the brand.
Press **ENTER** to confirm.

Audi

4. Turn **COOLIUS SELECT** to select the model.
Press **ENTER** to confirm.

Audi
A6 (4G)

5. Turn **COOLIUS SELECT** to select the version of the vehicle.
Press **ENTER** to confirm.

Audi
A6 (4G)

02/2011-

6. Refrigerant quantity and oil viscosity are shown.

Audi
A6 (4G)
ISO 46

g. 570

7. For more information, press *i* (INFO) key.

Press *i* key to go back.

Please refer to
the car manufacturer
technical
specifications!

8. Press **START** key to confirm.
The program is performed like [See chapter 5.2 Full service p. 25.](#)

Audi
A6 (4G)
ISO 46

g. 570

9. Turn **COOLIUS SELECT** to set (usually HP)
HP PORT / LP PORT / HP/LP PORTS

Press **ENTER** to confirm.

Charge A/C system by

HP PORT

5.4 Owner DataBase

In the OWNER DATABASE, you have the ability to create your own, frequently used vehicle data.

5.4.1 Creation of a vehicle

1. In the Menu A/C DATABASE turn **COOLIUS SELECT** counter clockwise, the display shows:

Confirm by **ENTER**.

NOTE: The display could show PLEASE WAIT! for a very short time.



Owner DataBase

2. The display shows:

Confirm by **ENTER** to create a new vehicle or **STOP** to exit.



New Model?

3. Type the brand of the vehicle.

NOTE: The field cannot be empty and a space is not allowed as a first character.

4. When the brand is filed, press **START** to confirm.



Brand:



A

3 4 5 6 7 8 9 0

BCDEFGHIJK

5. Type the model of the vehicle.

NOTE: The field cannot be empty and a space is not allowed as a first character.

6. When the model is filed, press **START** to confirm.
The display shows:



Model:



A

3 4 5 6 7 8 9 0

BCDEFGHIJK

7. Set the quantity of refrigerant by **COOLIUS SELECT** (from 50 to 25.000). Press **START** to save.

The record is saved in alphabetical order.



Quantity:

g . 500

5.4.2 Selection of a vehicle

1. Enter in A/C DATABASE.

Turn **COOLIUS SELECT** counter clockwise, the display shows:



UserBrand

UserModel

g . 500

INFO

2. Turn **COOLIUS SELECT** to select the desired vehicle, then press **ENTER** to use it, or **STOP** to exit.



Automatic

- Turn **COOLIUS SELECT** to choose between:
 - AUTOMATIC:** The machine performs a complete process using the default values for oil and UV (set in MACHINE SET-UP).
 - MANUAL:** The machine goes to the complete process set-up
[See chapter 5.5 Open program p. 30](#)
 RECOVERY / VACUUM / A/C SYSTEM CHARGE.
- Press **ENTER** to confirm or **STOP** to go back to the Owner DataBase list of vehicles.

5.4.3 How to modify or delete a saved vehicle

- Enter in A/C DATABASE.

Turn **COOLIUS SELECT** counter clockwise, the display shows:

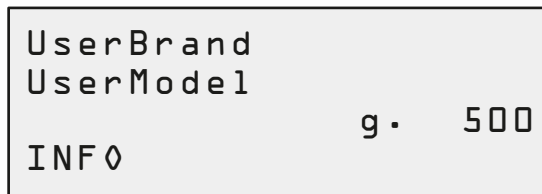

- Press **i** (INFO) key, then the display shows:

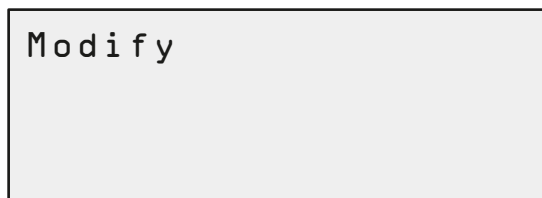

- Turn **COOLIUS SELECT** to select between **MODIFY** and **DELETE**, then press **ENTER** to confirm or **STOP** to go back to the Owner DataBase list of vehicles.

- MODIFY:** Overwrite the existing **BRAND**, **MODEL** and **QUANTITY** fields for the selected vehicle as shown in **CREATION OF A VEHICLE**.
[See chapter 5.4.1 Creation of a vehicle p. 28](#)

- DELETE:** Press **START** to confirm when the display shows:

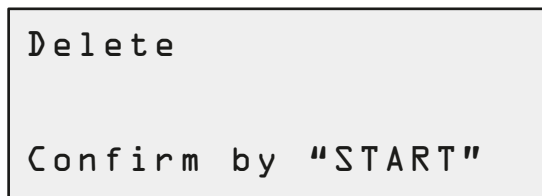

Wait a few seconds.

NOTE: The waiting time increases as the number of vehicles in the Owner DataBase becomes larger.

The vehicle is now deleted and the machine goes to the Owner DataBase list of vehicles.

5.5 Open program

1. Press **ENTER** to go to selection menu (if in Stand-by mode).

Open program

2. Press **ENTER** to confirm.

□□□■□

3. Turn **COOLIUS SELECT** to select the program or more programs.

Recovery

The following selections are available:

- "RECOVERY"
- "VACUUM"
- "A/C SYSTEM CHARGE"
- "RECOVERY / VACUUM"
- "VACUUM / A/C SYSTEM CHARGE"
- "RECOVERY / VACUUM / A/C SYSTEM CHARGE"

4. Press **ENTER** to confirm.

5.5.1 Process setting

Recovery

1. Turn **COOLIUS SELECT** to set the value.

- Minimum: 1 min.
- Maximum: 60 min.

Residual refrigerant
check.

min. 2

2. Press **ENTER** to confirm.

Vacuum

1. Turn **COOLIUS SELECT** to set the vacuum time.

- Minimum: 0 min.
- Maximum: 900 min.

NOTE: 0 means infinite Vacuum time (keep **STOP** key pressed down for 3 sec. to end Vacuum phase)

2. Press **ENTER** to confirm.

3. Turn **COOLIUS SELECT** to set the leak test time.

- Minimum: 2 min.
- Maximum: 60 min.

4. Press **ENTER** to confirm.

Vacuum time

min. 20

Leak test

min. _

A/C system charge

A) In case of vacuum selected:

1. Turn **COOLIUS SELECT** to set the Fresh oil value.

NOTE: The value indicates only the new oil added to the drained oil.

- Minimum: 0 g.
 - Maximum: 150 g.
2. Press **ENTER** to confirm.
 3. Turn **COOLIUS SELECT** to set the refrigerant amount.
 - Minimum: 50 g.
 4. Press **ENTER** to confirm.

PAG Oil	ml.	10
UV Dye	ml.	—
Refrigerant	g.	_____

B) In case of vacuum not selected:

Refrigerant	g.	_____
-------------	----	-------

C) In case of A/C system charge:

5. Turn **COOLIUS SELECT** to set (usually HP).
HP PORT / LP PORT / HP/LP PORT
6. Press **ENTER** to confirm.
7. Input **CAR DATA**, then press **START** key to confirm.
The equipment performs all the selected processes.

Charge A/C system by
HP PORT

5.6 A/C pressure test

This procedure allows to check the A/C system (pressures) without recovering refrigerant from the system.

1. Press **ENTER** to confirm.

A/C Pressure Test

2. Perform the pressure test.
At the end confirm by **STOP**.

Start the engine and
the A/C System!
Verify the A/C
system pressures

3. Perform the instruction.
Press **START** to confirm

Disconnect the HP
service hose (red)
from the A/C system

4. Wait the end.

Refrigerant recovery
from the
service hoses.

5.7 A/C flushing (UNLOCK CODE required)

The flushing UNLOCK CODE is required to activate the A/C flushing process, please retrieve it on the website www.coolius-ac.com or call your service partner.

1. Press **START** to confirm.

```
Get UNLOCK CODE
register:
                CC222222
www.coolius-ac.com
```

2. Enter the UNLOCK CODE using **COOLIUS SELECT**.

```
A*****
                A
34567890      BCDEFGHIJK
```

3. Once done, confirm by **START**.



In order to clean the vehicle A/C system, the equipment performs a washing process in “single” or “multi pass” (multiple flushes). For more details, refer to the A/C system manufacturers.

1. Press **ENTER** to confirm.

2. Turn **COOLIUS SELECT** to select
OTHER SELECTIONS confirm by **ENTER** then
A/C FLUSHING.

3. Press **ENTER** to select.

```
A/C Flushing
□□■□□□□□□□
```

4. Turn **COOLIUS SELECT** to set from 01 to 04 steps
(flushes).

Enter CAR DATA and press **START** to confirm.

```
A/C Flushing
Set flushes
required:                01
```

5. Press **START** key to confirm.

```
Confirm by "START"
```

The “single” or “multi pass” process is carried out.

NOTE: Appropriate adaptors for the compressor/expansion valve are required.

```
Flushing in process
Please wait!
>>>
```

```
Flushing completed.
Oil                ml. //
```

6 Maintenance



NOTE: Maintenance of the vacuum pump must be performed every 3000 minutes or at the latest after one year of operation, whichever is sooner.



ATTENTION! Damage to the machine!
Maintenance can be made exclusively by SERVICE CENTER authorized by the manufacturer.



1. Press **ENTER** to go to selection menu (if in Stand-by mode).
2. Turn **COOLIUS SELECT** to select OTHER SELECTIONS and confirm by **ENTER**. Then select MAINTENANCE and confirm by **ENTER**.

```
Select:
Historical counters
```

Available selections:

- HISTORICAL COUNTERS
 - NEXT SERVICE
 - COUNTER RESET
(UNLOCK CODE required)
 - REPORT
3. Press **ENTER** to confirm.

6.1 Operation history

This menu allows to check the operation history of the machine. The data are not erasable!

1. Turn **COOLIUS SELECT** to select the following counters:
 - REFRIGERANT RECOVERED FROM A/C SYSTEM
 - REFRIGERANT RECOVERED FROM EXTERNAL TANK
 - REFRIGERANT CHARGED TO A/C SYSTEM
 - VACUUM WORKING TIME

```
Select counter.
R134a recovered
Total
Kg.                ///. /
```

6.2 Next service

This menu allows to check the next service required:

```
Maintenance within
                 3600 min.
pump working time.
```

6.3 Counter reset (UNLOCK CODE required)



NOTE: Change the filter and/or the vacuum pump oil before reset!

NOTE: Only genuine spare parts or their equivalent. The use of replacement parts which are not of equivalent quality may damage the machine!

Go to website www.coolius-ac.com or call your service partner to get the UNLOCK CODE for maintenance counter reset..

1. Press **ENTER** to type the unlock code.
2. Use the **COOLIUS SELECT** to enter the maintenance UNLOCK CODE obtained from www.coolius-ac.com.

Confirm by **START** when done.

- If the UNLOCK CODE is wrong, repeat the step 2.
- If the UNLOCK CODE is right, go to step 3:

3. The display shows:

Press **X** key to confirm.

4. Press again **X** key to confirm.

Maintenance reset successfully completed.

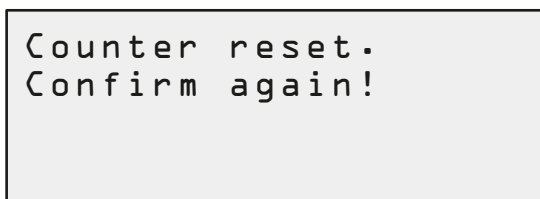
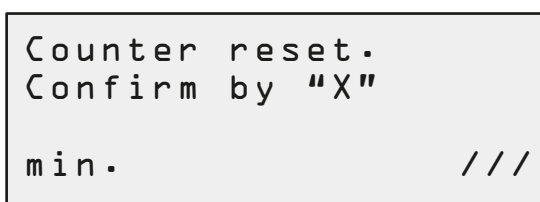
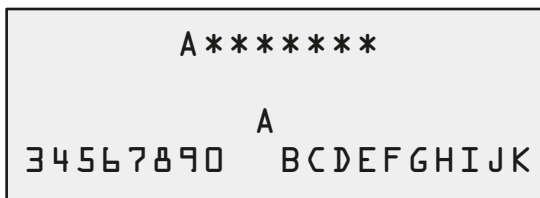

6.4 Filter replacement



ATTENTION! Risk of injury from leaking refrigerant.

Contact with the refrigerant can cause blindness and other physical injury to the user!

Always use goggles and gloves!



1. Before dismantling the filter, start a recovery process to reduce the internal pressure!



ATTENTION! Risk of injury from electric shock.

Before working on the machine, always disconnect the plug from the power supply.

The maintenance of the filter can be performed by the inspection hole placed on the back side of the equipment.

2. By 38 mm **②** wrench unscrew the filter **①**.



NOTE! Disposal in according to local directives!

3. Lubricate and place correctly the new O-rings.
4. Assembly the new filter.

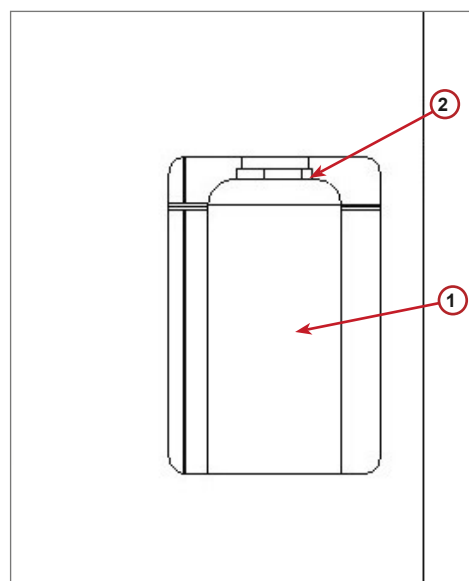

fig. 018 Filter replacement

6.5 Vacuum pump oil replacement



ATTENTION! Risk of injury from leaking refrigerant.
Contact with the refrigerant can cause blindness and other physical injury to the user!
Always use goggles and gloves!



ATTENTION! Risk of injury from electric shock.
Before working on the machine, always disconnect the plug from the power supply.



NOTE! The oil extracted must be delivered to used oil collection centre!

1. Dismount the front cover.
2. Unscrew the oil discharge screw and wait for the oil to drain. Refit discharge screw.
3. Unscrew the muffler.
4. Fill with new oil. The correct oil level of the pump is around half sight glass.
5. Refit the muffler.
6. Close the front cover.
The machine cannot be used with the front cover opened.

NOTE: The picture could show a different type of vacuum pump.

- (A) Muffler
- (B) Sight glass to indicate the oil level
- (C) Discharge screw

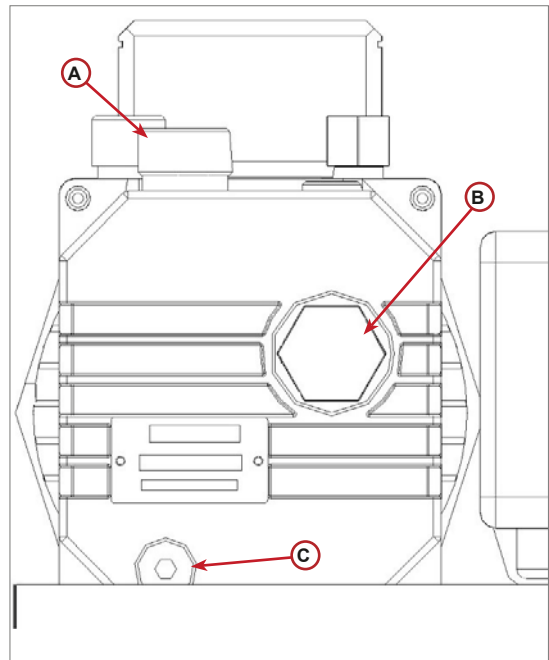

fig. 019 Vacuum pump

6.6 Report

The machine records the refrigerant usage monthly for the previous twelve months. Beyond this period, it will overwrite the data for the month in question.

1. Turn **COOLIUS SELECT** to select the following counters:
 - "REFRIGERANT RECOVERED FROM A/C SYSTEM"
 - "REFRIGERANT RECOVERED FROM EXTERNAL TANK"
 - "REFRIGERANT FILLED TO A/C SYSTEM"

```
01/2020
R134a recovered
Kg.                10.0
```

The display shows in sequence all the months and the total per year.

2. Press **START** to print the report.

```
2020
Total
R134a recovered
Kg.                210
```

6.7 Scale reset

In order to compensate the scale deviation, perform the following instructions:

1. Turn **COOLIUS SELECT** to select OTHER SELECTIONS, confirm by **ENTER**,
2. Turn **COOLIUS SELECT** to select SCALE RESET
3. Press **ENTER** to confirm.
4. Turn **COOLIUS SELECT** to select the scale:
 - "REFRIGERANT WEIGHT SCALE"
 - "WASTE OIL WEIGHT SCALE"
5. Press **ENTER** to confirm.

```
Scale reset
```

```
Select:
Refrig. Weight scale
```

6.7.1 Refrigerant Weight scale

1. Unload the scale (safety position) by using the transportation screws.
2. Press **START** key to confirm scale unloaded.

Unload weight scale
(safety position)



WARNING! Confirm by **START** only if the scale is unloaded!

3. At the end, load the scale (working position) by unscrewing the transportation screws.

In case of mistake:
Perform again the procedure and be sure to follow correctly the instructions!

Reset not possible!
Scale not unloaded
PLS unload the scale
before reset.

6.7.2 Waste oil weight scale

1. Disconnect the waste oil bottle from its coupler.
2. Press **START** key to confirm bottle disconnected.



WARNING! Confirm by **START** only if the waste oil bottle is disconnected!

Unload used oil
scale!

3. Wait the end, then reconnect the waste oil bottle.

7 Technical features

Model	COOLIUS A30
Power	230V+/-10% 50Hz
Operating temperature range	10/49 °C
Refrigerant	R134a
Internal vessel capacity (Kg)	35 kg
Maximum pressure (PS)	20 bar
Compressor	5/8 HP
Recovery rate (liquid)	980 g/min'
Not condensable gas discharge	Automatic
Main drier filter	Coaxial
Ventilation Security System	80 mm
Recovery high speed fan	172 mm
Internal vessel pressure gauge	D40 mm
Oil discharge	Automatic
Bottle capacity	1000 ml
Refrigerant Weight scale	200 kg
Scale accuracy (+/-)	2 g
Vacuum pump	170 lt/min
Final pressure (McLeod abs)	0,05 mb
Electronic vacuum meter	YES
PAG oil charge	Automatic
Bottle capacity	500 ml
UV Dye charge	Automatic
Bottle capacity	250 ml
Refrigerant charge	Automatic
Service hoses compensation	Automatic
Flushing program	On demand
Workshop program	YES
Configuration	
Display	4 x 20 characters
Keyboard with COOLIUS SELECT	YES
Vehicle Database	YES
Printer	YES
Pressure gauges (pulse free) CL 1.0	D 80 mm
Service couplings	Parker SAE J639
Service hoses 5.0 m	SAE J2197
Service hoses extension kit to 8,0 m (additional 3.0 m)	On demand

8 Disposal

8.1 Storage for long periods

The machine should be positioned in a safe area, disconnected from the supply and protected from excessive temperatures and humidity.

8.2 Disposal of used fluids



NOTE! *Used oil is hazardous waste. Do not mix used oil with other fluids.
Keep used oil in suitable containers prior to disposal.*

The lubricants extracted from A/C system must be delivered to used oil collection centre!

8.3 Disposal of packaging material

- The cardboard packaging material should be disposed of with other waste paper.
- Plastic packaging material should be added to other recyclable waste.

8.4 Scrapping the old unit

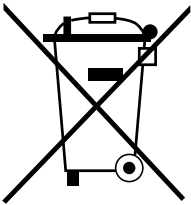

If you wish to scrap the Machine, first completely drain it of all liquids and dispose of them in an environmentally responsible manner.

Take the old unit to your nearest recycling centre or contact the customer service.



9 Contact and support



If you have further questions about the product or need help with the installation, our technical hotline staff will be happy to help you.

Contact information for your country's service partner can be found on our website  www.wow-portal.com/contact

Manufactured by:

WOW ! ITALY

Viale della Stazione 7
39100 Bolzano, Italy

Distributed by:

Germany

WOW! Würth Online World GmbH

Schliffenstraße 22
74653 Künzelsau

Phone: +49 7940 981 88 - 0
Fax: +49 7940 981 88 - 10 99
info@wow-portal.com
www.wow-portal.com

Germany

WABCOWÜRTH Workshop
Services GmbH

Schliffenstraße 22
74653 Künzelsau

Phone: +49 7940 981863-0
Fax: +49 7940 981863-5555
info@wabcowuerth.com
www.wabcowuerth.com

Sweden

AUTOCOM
Diagnostic Partner AB

Grafitvägen 23 B
461 38 Trollhättan, Schweden

Phone: +46 520 470 701
Fax: +46 520 470 727
info@autocom.se
www.autocom.se

Australia

Würth Australia Pty. Ltd.
Building 5, 43 - 63 Princes Highway
Dandenong South
Victoria 3175

Phone: 1300 65 77 65
Fax: 1800 03 23 96
info@wurth.com.au
http://www.wurth.com.au/

Contact person: John Tsakoumangos

New Zealand

Würth New Zealand Limited
PO Box 97079, Manukau 2241
99 McLaughlins Road,
Wiri 2104, Auckland

Phone: +64 926 230 40
Fax: +64 926 230 30
info@wurth.co.nz
http://www.wurth.co.nz/

Contact person: Conrad Bennett

Japan

Würth Japan Co., Ltd.
MT Building
33 Sanmai-cho, Kanagawa-ku
Yokohama 221-0862

Phone: +81 454 884 186
Fax: +81 454 884 187
support@wurth.co.jp
http://www.wuerth.co.jp/

China

Wuerth (China) Co., Ltd.
Building 5, No 51, Lane 1159 East
Kangqiao Road
Pudong District
201315 Shanghai

Phone: +86 215 029 76 66
marketing@wuerth.cn
legal@wuerth.cn
https://www.wuerth.cn

9.1 Service Portal

On the website  www.coolius-ac.com the activation of the machine can be carried out independently. In addition, you will find further help and instructions for your COOLIUS device on this website.



COOLIUS

WOW! ITALY
Viale della Stazione 7
39100 Bolzano
www.coolius-ac.com

Doc.No.: 22262-Rev.04.00
© by WOW! ITALY
All rights reserved.
Responsible for content: Product dept.